

- Note :** 1. Make sure the length of hose as required, cut off the extra length by knife and keep the edge leveled.
 2. O-rings are classified according to two brake fluid, DOT4 and MINERAL. Please choose the corresponding one. (Note: Do not mix using them)

Fit one end of hose to banjo unit

- 1-1 Make banjo bolt through banjo insert with proper O-rings on each side (as shown in Fig. 1&2) and fix on the caliper (as shown in Fig. 3&4) at a torque of 8~9 Nm(71~80 in.lbs).

Fit one end of hose to insert unit

- 2-1 Put connecting bolt, one-piece connecting insert through the hose in order (as shown in Fig. 5)., Fix it by using special purpose fixture (as shown in Fig. 6). Note: Fix and position one-piece connecting insert with hose firmly. (as shown in Fig. 7).

- 2-2 Fix the connecting bolt on the master cylinder or caliper by 8mm open wrench (as shown in Fig. 8&9) at a torque of 6-7Nm(54-62 in.lbs).

Fit one end of hose to M6 connector

- 3-1 Select and fix proper M6 connector and O-rings on the caliper (as shown in Fig. 10&11) at a torque of 6-7Nm (54-62 in.lbs) and then fix insert with M6 connector (as shown in Fig. 12) at a torque of 7~9 Nm (62~80 in.lbs).

油壓油管安裝說明書

- 注意：** 1. 確認油管長度後，以小刀或裁切工具切除多餘油管，油管切面需平整！
 2. O環有分為DOT 4 & 礦物油兩種，請依照剎車油係選用！（註：不可混用）

胡琴頭安裝

- 1-1 於胡琴接頭兩側分別放置O環(零件包選用)，使用原有注油螺絲穿過胡琴接頭與O環(FIG.1&2)，將胡琴接頭鎖設於卡鉗上(FIG.3&4)；鎖緊扭力8~9 Nm(71~80in.lbs)。

直接頭安裝

- 2-1 將油管螺絲、油管接頭(一體式)依序裝設於油管上(FIG. 5)。可使用專用治具來完成定位(FIG. 6)。(注意：油管接頭與油管需確實定位(FIG. 7)。

- 2-2 再使用8mm開口扳手將油管螺絲鎖付於卡鉗或總泵上(FIG. 8&9)；鎖緊扭力6-7Nm (54-62 in.lbs)。

油管裝M6接頭

- 3-1 將M6轉接頭(零件包選用)+O環(零件包選用)鎖設於卡鉗上(FIG.10&11)；鎖緊扭力6~7 Nm(54~62 in.lbs)，再將直接頭鎖設於M6轉接頭上即可(FIG.12)；鎖緊扭力7~9 Nm(62~80 in.lbs)。

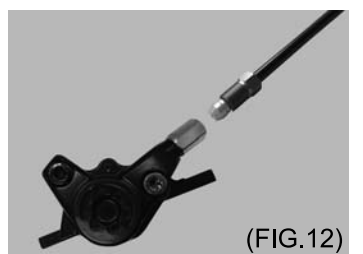
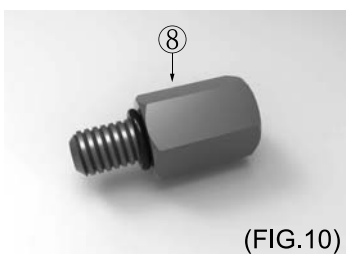
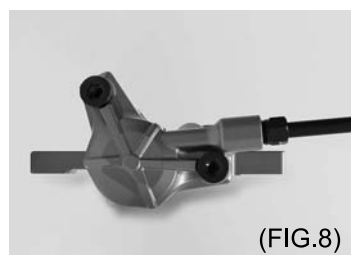
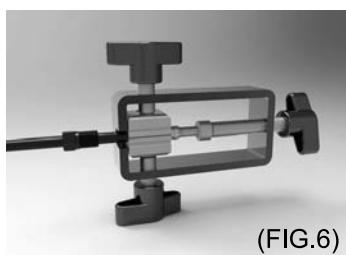
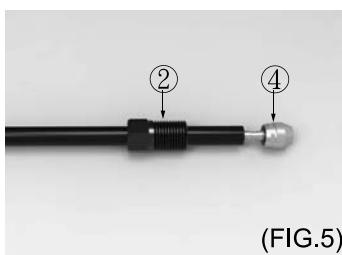

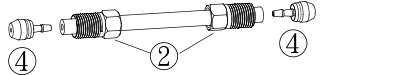
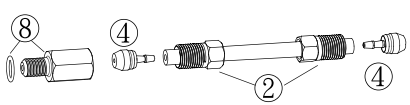

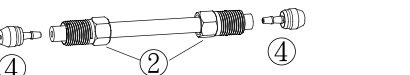

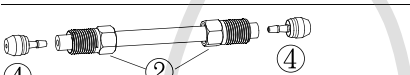
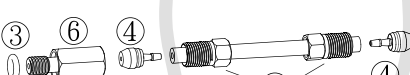

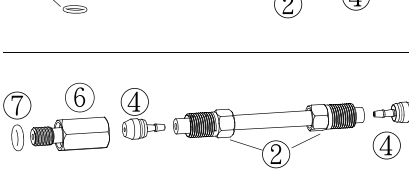



Chart 1 (對照表-附表一)

AVID/SRAM	Type (型號)
	JUICY 5/7 JUICY ULTIMATE XX 2010-2014
	JUICY 3/3.5 CODE/5/R ELIXIR 1/3
	ELIXIR R/CR/5/7/9 CODE/5 XX/XO Guide RSC/RS/R/DB5

BENGAL	Type (型號)
	HELIX 1.0/1.1 HELIX 3 SL/3 CARBON HELIX 4X/5L/7B
	HELIX 2.1/2.3/3 HELIX 2.5/5/6/7/7L/7.5 ARES/1/3
	ARES5/PRO

HAYES	Type (型號)
	STROKER TRAIL CARBON/ACE/GRAM EL CAMINO PRIME PRO/EXPERT/COMP
	STROKER RYDE/DYNO PRIME SPORT/RADAR
	NINE

MAGURA	Type (型號)
	LOUISE FR
	LOUISE MARTA/SL

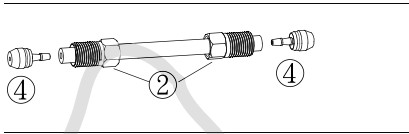
SHIMANO	Type (型號)
	XTR DEORE XT 2012-2015 SLX 2012-2015 SAINT/ZEE/S700
	DEORE /DEORE LX DEORE XT 2005-2011 M4050/575/395/355 SLX 2009-2011

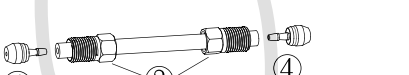
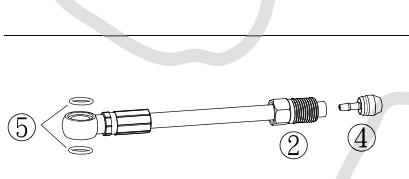
TEKTRO	Type (型號)
	AURIGA PRO 2009-2010 AURIGA COMP/COME WS DRACO/GEMINI/DRACO2 HDC330/XIURIGA/VELA AURIGA-E-COMP
	AURIGA PRO 2011/ORION SL ORION/GEMINI SL/VOLANS XIURIGA-TUNE/AURIGA-SUB DORADO/XIURIGA-E-TUNE AURIGA-E-SUB

Parts (Please refer to chart 1)

No.	Description	Qty	Application
①	O-ring 6X1 (Dot4)	4	Banjo kit
②	Connecting bolt	4	Insert kit
③	O-ring 4.8X1.9 (Dot4)	2	M6 Connector
④	Connecting insert	4	Insert kit
⑤	O-ring 6X1 (Mineral)	4	Banjo Kit
⑥	M6 Connector	2	(HAYES/MAGURA)
⑦	O-ring 4.8X1.9 (Mineral)	2	M6 Connector
⑧	M6 Connector+O-ring 5.8X1.2	2	(AVID)

零件包 (請參考對照表-附表一)

號碼	名稱	數量	適用
①	O環6X1 (Dot4)	4	胡琴頭
②	油管螺絲	4	直接頭
③	O環4.8X1.9 (Dot4)	2	M6轉接頭
④	油管接頭	4	直接頭
⑤	O環6X1 (礦物油)	4	胡琴頭
⑥	M6轉接頭	2	(HAYES/MAGURA)
⑦	O環4.8X1.9 (礦物油)	2	M6轉接頭
⑧	M6轉接頭+O環5.8X1.2	2	(AVID)

