

## BENGAL Warranty Service Center And Distributor Information

### Brazil Distributor

**J.T.COM IMP E EXP LTDA**  
TEL/FAX:+55-11-5678-2694  
Website: www.joytech.com.br

### China General Distributor

**(China Warranty Service Center)**  
**LEADING COMPONENTS (S.Z.) CO., LTD.**

(A plant) 5F, No.14 ZhengxingRoad,  
Liyuhe IndustrialDistrict,LouVillage,  
Gongming Town,Shenzhen,518106  
TEL: 0755-23194955/6 FAX:0755-23194953  
Contact: robert6402@kimo.com

### Malaysia Distributor

**Evanda Sdn Bhd (812810-X)**

Lot 153 (No 1) , Jalan TIAJ 2/1 ,Taman Industri  
Alam Jaya ,42300 Bandar Puncak Alam ,  
Selangor , Malaysia  
TEL:+6 03 60388929 / 6038 8928  
Contact: evanda\_rmb@yahoo.com

### Singapore Distributor

**(Singapore Warranty Service Center)**  
**D-CYCLEWERKZ**

2 YISHUN INDUSTRIAL STREET 1, #01-15 NORTHPOINT  
BIZHUB,SINGAPORE 768159  
TEL:+65 67523457  
Contact: dcyclewerkz8@gmail.com

### Spain & Andorra Distributor

**RACING CYCLE**  
Rua dos Lagoeiros armz 54 2415 -645 Leiria Portugal  
Tel:+351 244 027 587 / +351 244 043 616  
Contact: info@racingcycle.net

### Switzerland Distributor

**(European Warranty Service Center)**

**3LMNT Distribution Inc., Corp.**  
Römerstrasse 15a, CH-2555 Brugg , Switzerland  
TEL: +41-78-666-42-17 FAX:+41-78-666-42-17  
Contact: info@3lmnt.com

### Taiwan Distributor

**HARVEST YEAR TECHNOLOGY COMPANY**

No.70-3, Zhonglu rd., Xiushui Township,  
Changhua County 504, Taiwan  
TEL: +886-4-7691929 FAX: +886-4-7691858  
Contact: hy.bike88@msa.hinet.net

### USA & Canada Warranty Service Center

**KHS, Inc**  
2840 Harcourt St.Rancho Dominguez, Ca. 90221 USA  
TEL: 1-800-347-7854\*212  
Contact: rogerj@khsbicycles.com

### Portugal Distributor

**RACING CYCLE**  
Rua dos Lagoeiros armz 54 2415 -645 Leiria Portugal  
Tel:+351 244 027 587 / +351 244 043 616  
Contact: info@racingcycle.net

# 2018



The latest distributor information will be updated , please refer to our website

**Bengal Performance Brake Systems**  
sales@bengalperformance.com.tw  
www.bengalperformance.com.tw



# Hydraulic Disc Brake

## Technical features

- Open hydraulic disc brake system
- Aluminum forged master cylinder and caliper
- Master cylinder with reach adjustment
- "EZ-adjust" hose connector, adjustable up to 180 degrees
- Window for driver easily inspect if pads have worn, clean and mud out
- 2-Piece bracket for easy assembly
- Perfect for XC, TRAIL, AM, FR, DH

## ARES 5

### Weight

- Master cylinder : 90g
- Caliper : 120g

### Rotor

- OD-160C (6-bolt or center lock)
- Optional OD-180C/ OD-203C

### Lever

- 1.5 finger blade

### Finish

- Black

### Fluid

- Mineral

### Pad

- Semi-metallic compound



Two-piece

"EZ-adjust" hose connector  
Adjustable up to 180 degrees



## Tool free reach adjustment (Optional)



SHIMANO  
Shifter mount clamp



SRAM  
Shifter mount clamp



## EZ PLUG IN (Optional)

Setp.1



Through the frame

Setp.2



Remove the insert

Setp.3



Unscrew the bolt

Setp.4



Fasten the hose kit

PATENT NO : M518750/ZL201520796991.9



# Hydraulic Disc Brake

## Technical features

- Open hydraulic disc brake system
- Aluminum forged master cylinder and caliper
- Master cylinder with reach adjustment
- Patented "EZ-out" brake pad replacement
- Window for driver easily inspect if pads have worn, clean and mud out
- Perfect for XC, TRAIL, AM

## ARES 3

### Weight

- Master cylinder : 102g
- Caliper : 120g

### Rotor

- OD-160C (6-bolt or center lock)
- Optional OD-180C / OD-203C

### Lever

- 2 finger blade

### Finish

- Black

### Fluid

- Mineral

### Pad

- Semi-metallic compound



Signal connection switch (Optional) Perfect for E-bike

Waterproof type

General type



Optional connector types



EZ PLUG IN (Optional)

Setp.1



Through the frame

Setp.2



Remove the insert

Setp.3



Unscrew the bolt

Setp.4



Fasten the hose kit

PATENT NO : M518750/ZL201520796991.9

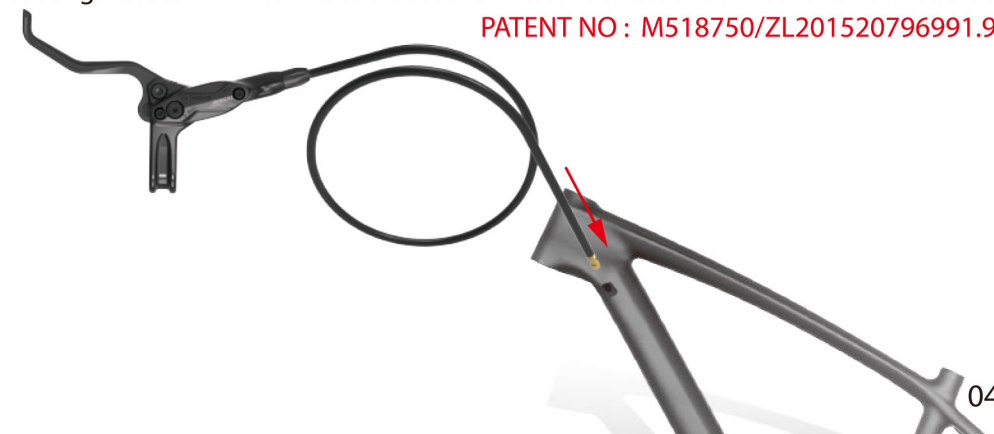

# Hydraulic Disc Brake

## Technical features

Open hydraulic disc brake system  
Aluminum forged master cylinder and caliper  
Master cylinder with reach adjustment  
Patented "EZ-out" brake pad replacement  
Window for driver easily inspect if pads have worn, clean and mud out  
Perfect for XC, TRAIL, AM

### ARES 1

#### Weight

Master cylinder : 68g

Caliper : 120g

#### Rotor

OD-160C (6-bolt or center lock)

Optional OD-180C/ OD-203C

#### Lever

2 finger blade

#### Finish

Black

#### Fluid

Mineral

#### Pad

Semi-metallic compound



## Technical features

Open hydraulic disc brake system  
Aluminum forged master cylinder and caliper  
Master cylinder with reach adjustment  
Patented "EZ-out" brake pad replacement  
Window for driver easily inspect if pads have worn, clean and mud out  
Perfect for XC, TRAIL, AM

### ARES

#### Weight

Master cylinder : 105g

Caliper : 120g

#### Rotor

OD-160C (6-bolt or center lock)

Optional OD-180C/ OD-203C

#### Lever

2.5 finger blade

#### Finish

Black

#### Fluid

Mineral

#### Pad

Semi-metallic compound

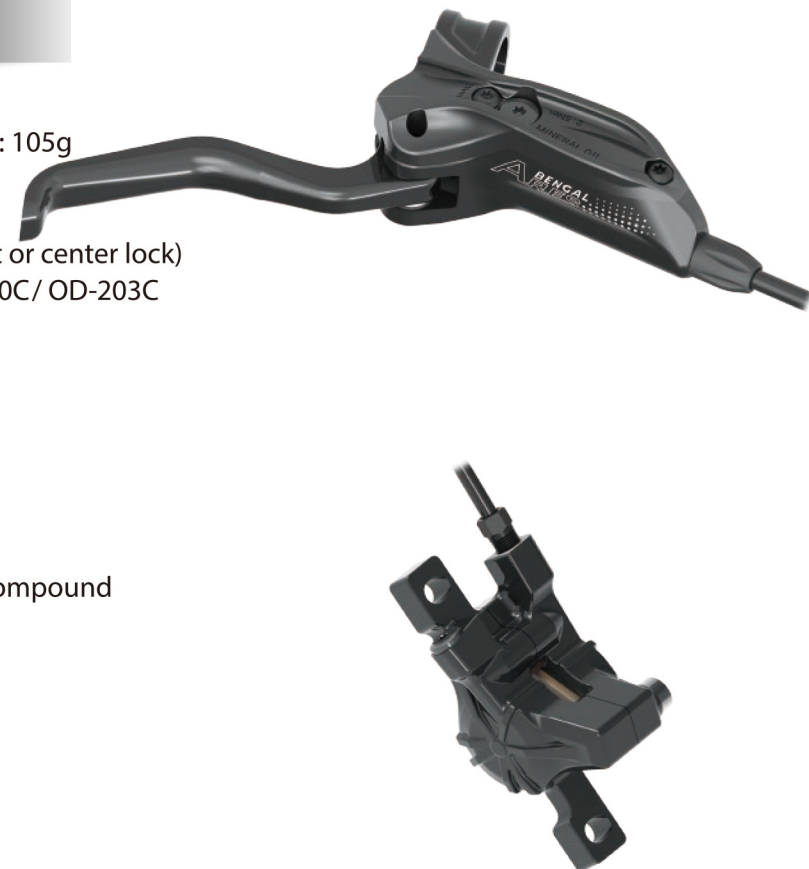

## Hydraulic Disc Brake

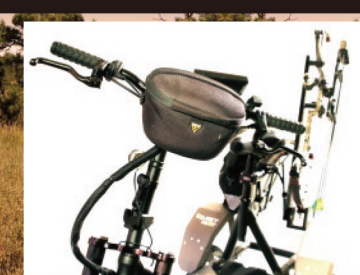

### Technical features

- Open hydraulic disc brake system
- Aluminum forged master cylinder and caliper
- Master cylinder with reach adjustment
- Patented "EZ-out" brake pad replacement
- Window for driver easily inspect if pads have worn, clean and mud out
- Perfect for XC, TRAIL, AM

## HELIX 7

### Weight

- Master cylinder : 88g
- Caliper : 120g

### Rotor

- OD-160C (6-bolt or center lock)
- Optional OD-180C / OD-203C

### Lever

- 2 finger blade

### Finish

- Black

### Fluid

- Dot 4

### Pad

- Semi-metallic compound



### Technical features

- Open hydraulic disc brake system
- Aluminum forged master cylinder and caliper
- Patented "EZ-out" brake pad replacement
- Window for driver easily inspect if pads have worn, clean and mud out
- One master cylinder with dual caliper
- Lever can be assembled with stop devices (stop pin, or cut-off sensor, or both)
- Perfect for TRICYCLE, PEDICAB, E-BIKE, SPECIAL TYPE

## HELIX 7.5

### Weight

- Master cylinder : 100g
- Caliper : 120g

### Rotor

- OD-160C
- Optional OD-180C / OD-203C

### Lever

- 4 finger blade

### Finish

- Black

### Fluid

- Dot 4

### Pad

- Semi-metallic compound



# Mechanical Disc Brake Dual-sided



MB300, is a mechanical disc brake designed by veering away from traditional techniques and discovering a new dual-sided patented structured design. The MB300's one piece and competitive lightweight design offer easy setup and adjustment. The unique positioning of the pads between the sides of the rotor provides incredible performance. Furthermore, MB300's breakthrough design finally solves the issue of rotor deformation caused by traditional unilateral action. The dual-sided design gives this brake multiple advantages over its competitors. Plus, MB300 is suitable for any levers on the market and one of the best performing on the world.

PATENT NO : M533615/15.201,543/ZL2016205986261/Nr.20 2016 104 048

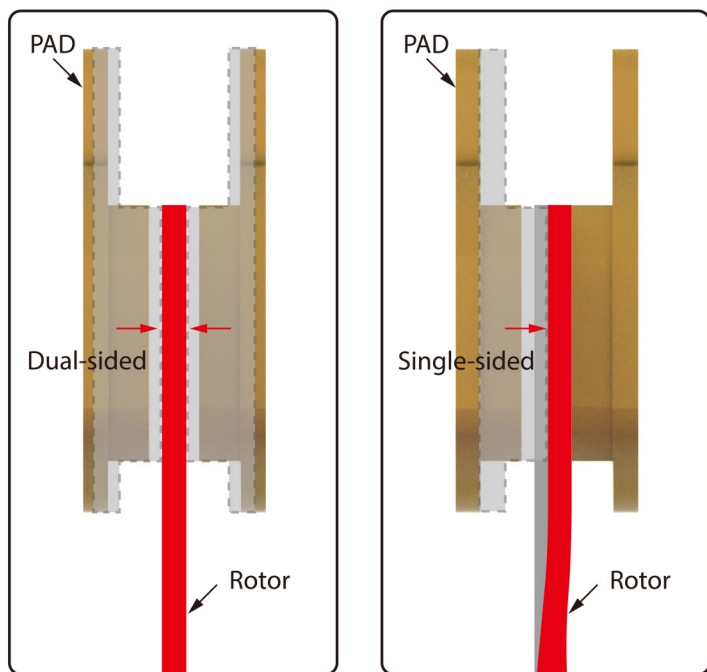

## Technical features

It gives the brake actuator synchronized with two sides  
 Easy to assembly and manually adjust the gap of two sides  
 Window for driver easily inspect if pads have worn, clean and mud out  
 Compact, light weight, 1-piece aluminum caliper design

### MB 300



Perfect for : MTB, URBAN

Finish : Black

Rotor : OD-160C (6-bolt or center lock)

Optional OD-180C/ OD-203C

Pad : Semi-metallic compound

Frame	Caliper	front rear	160	180	203
IS	IS	F R	DM DM		
PM	PM	F R	DM DM		
IS	PM	F R		U3 U4	U5 U6

### MB 300T



Perfect for : Road bike, Gravel Bike,  
 Cycloross and  
 STI lever bike

Finish : Black

Rotor : OD-140C

Optional OD-160C

Pad : Semi-metallic compound

Frame	Caliper	front rear	140	160
FM	FM	F R	F1 DM	F1 F2
PM	PM	F R		DM DM
IS	IS	F R		DM DM

IS



170g

PM



152g

FM



148g

# Mechanical Disc Brake

Single piston activation for peak stopping power "PSP"  
Non-binding groove proline cable routing that keeps the cable in direct pull between the anchor bolt and the cable housing  
Window for driver easily inspect if pads have worn, clean and mud out

## MB 700

### Technical features

Compact, light weight, 1-piece aluminum forged caliper design  
Perfect for : MTB, URBAN

Weight : 166g  
Finish : Black  
Rotor : OD-160C (6-bolt or center lock)  
Optional OD-180C / OD-203C  
Pad : Semi-metallic compound



## MB 700T

### Technical features

Compact, light weight, 1-piece aluminum forged caliper design  
Perfect for : Road bike, Touring bike, Cyclocross bike  
and STI lever bike

Weight : 166g  
Finish : Black  
Rotor : OD-140L (6-bolt or center lock)  
Optional OD-160L / OD-180L / OD-203L  
Pad : Semi-metallic compound



## MB 600

### Technical features

2-piece uniform casting process design  
Perfect for : MTB, URBAN

Weight : 210g  
Finish : Black  
Rotor : OD-160C (6-bolt or center lock)  
Optional OD-180C / OD-203C  
Pad : Semi-metallic compound



## MB 845A

### Technical features

2-piece uniform casting process design  
Perfect for : MTB, URBAN, TRICYCLE, PEDICAB, E-BIKE

Weight : 218g  
Finish : Black  
Rotor : OD-160C  
Optional OD-180C / OD-203C  
Pad : Semi-metallic compound



## MB 500

### Technical features

2-piece uniform casting process design  
Perfect for : MTB, URBAN

Weight : 210g  
Finish : Black  
Rotor : OD-160C (6-bolt or center lock)  
Optional OD-180C / OD-203C  
Pad : Semi-metallic compound



## MB 845B

### Technical features

Special design for the right side mount  
2-piece uniform casting process design  
Perfect for : MTB, URBAN, TRICYCLE, PEDICAB, E-BIKE

Weight : 218g  
Finish : Black  
Rotor : OD-160C  
Optional OD-180C / OD-203C  
Pad : Semi-metallic compound



# ROTORs

	Wave	6 (C)	12 (L)	6 (CC)	12 (LC)
Rotor OD	Size	Weight	Weight	Weight	Weight
120mm	4"	90g	66g	120g	96g
140mm	5"	102g	86g	132g	116g
160mm	6"	136g	104g	166g	134g
180mm	7"	173g	134g	203g	164g
203mm	8"	225g	172g	255g	202g

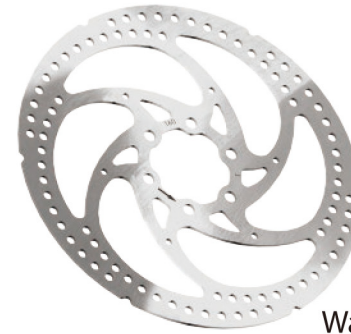

Wave 6 (C)



Wave 12 (L)

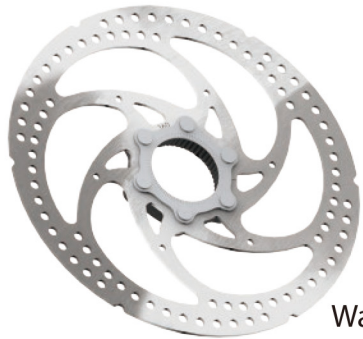

Wave 6 (CC)

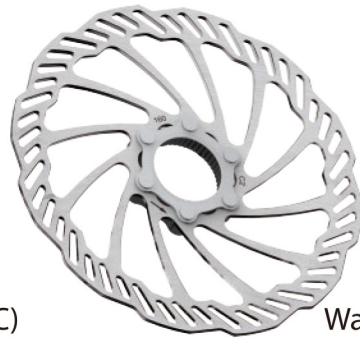

Wave 12 (LC)

## ADAPTORS

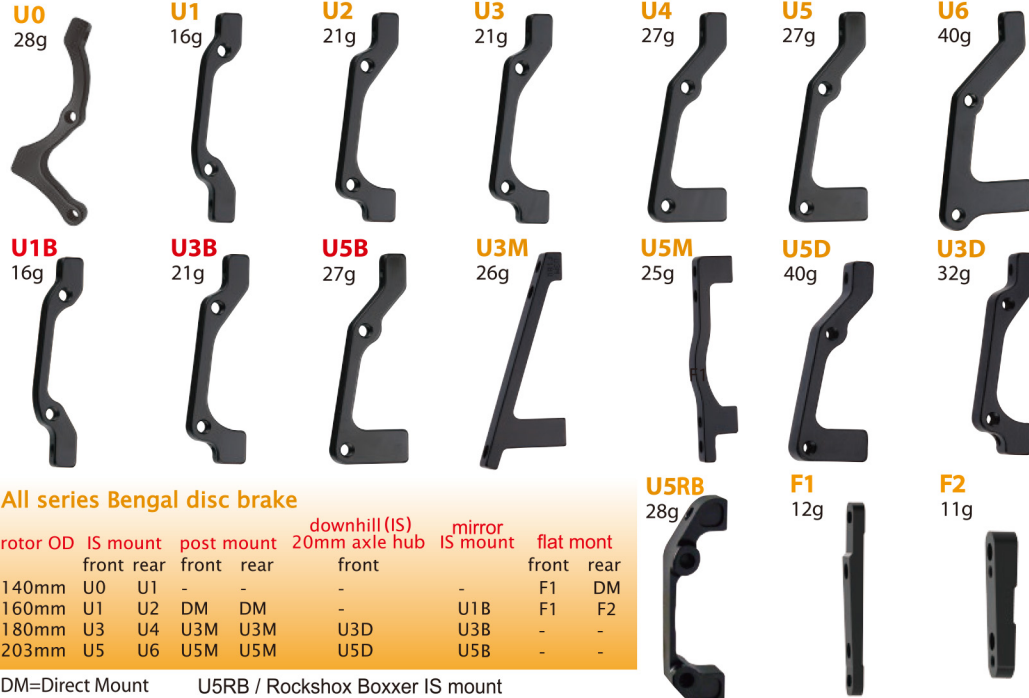

### All series Bengal disc brake

rotor OD	IS mount		post mount		downhill (IS) 20mm axle hub		mirror IS mount		flat mount	
	front	rear	front	rear	front	rear	front	rear	front	rear
140mm	U0	U1	-	-	-	-	-	-	F1	DM
160mm	U1	U2	DM	DM	-	-	U1B	-	F1	F2
180mm	U3	U4	U3M	U3M	U3D	-	U3B	-	-	-
203mm	U5	U6	U5M	U5M	U5D	-	U5B	-	-	-

DM=Direct Mount U5RB / Rockshox Boxxer IS mount

## Automatic oil injection

### Technical features

- Easy and convenient operation and light design (electricity and air compression)
- Automatically drain the old brake oil and inject new brake oil to avoid the unskilled bleeding technique by people which may cause insufficient oil and lead to defective brake performance.
- Oil changing within 3 to 5 minutes for one wheel
- Compatible with 90% bicycle brake systems
- Suggest changing oil once a year.
- Application programs can be updated.

**Weight :** 17kg

**Pressure source :** 5~8Kg/cm<sup>2</sup>

**Size(cm) :** 34 \* 30 \* 86

**Voltage :** 100V-240V~AC50Hz-60Hz

**B030M ( Mineral )**

**Range :** BENGAL/MAGURA/SHIMANO  
TEKTRO

**PATENT NO :**

M436117

US 9,120,475

ZL201220164186.0

Nr.202012102412.8

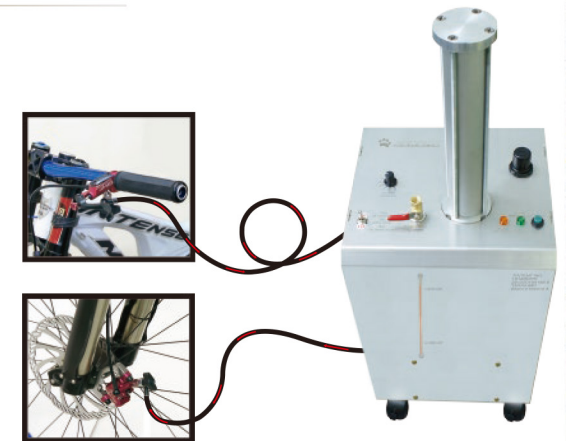

Automatic oil injection for hydraulic disc brakes

Changing oil easily Riding bicycles safely